



OPTO ENGINEERING

ILLUMINATOR DATA

LT2QOG040-00-X-W-24V

Lighting Dimension

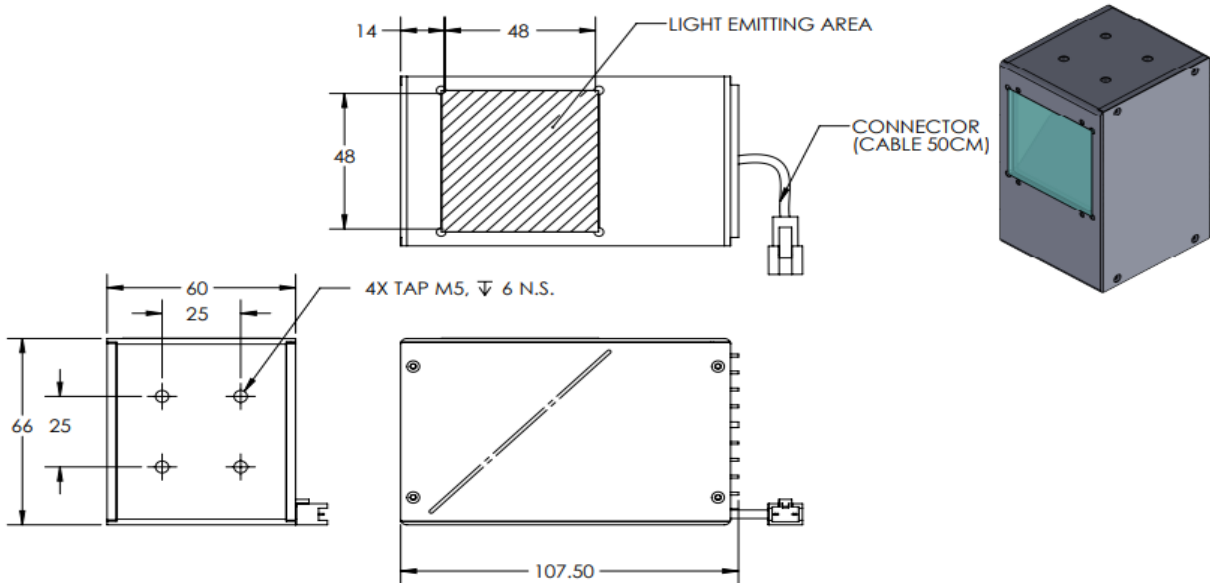

Mechanical Information

Casing Material	Aluminium
Storage Temperature Range	0 - 45°C
Storage Humidity Range	20 - 85%
Weight	360 g
Length / Outer Diameter	107.5 mm
Width / Inner Diameter	60 mm
Thickness / Height	66 mm



OPTO ENGINEERING

ILLUMINATOR DATA

LT2QOG040-00-X-W-24V

Lighting Information																														
Part Number	LT2QOG040-00-X-W-24V																													
LED Color	WHITE																													
Wavelength	REFER TO CHROMACITY TABLE																													
Working Distance	20 mm	30 mm	50 mm																											
Intensity (±15%)	15400 lx	11960 lx	6470 lx																											
Illumination (number of row)	X																													
Illumination Active Area	Active Length / Outer Dia.			48 mm																										
	Active Width / Inner Dia.			48 mm																										
Emission angle	0																													
Eye Safety Class (IEC62471)	EXEMPT																													
Chromaticity Table	<table border="1"> <tr> <td>X</td> <td>0.296</td> <td>0.287</td> <td>0.307</td> <td>0.311</td> </tr> <tr> <td>Y</td> <td>0.276</td> <td>0.295</td> <td>0.315</td> <td>0.294</td> </tr> </table>					X	0.296	0.287	0.307	0.311	Y	0.276	0.295	0.315	0.294	<table border="1"> <tr> <td>X</td> <td>0.311</td> <td>0.307</td> <td>0.33</td> <td>0.33</td> </tr> <tr> <td>Y</td> <td>0.294</td> <td>0.315</td> <td>0.339</td> <td>0.318</td> </tr> </table>					X	0.311	0.307	0.33	0.33	Y	0.294	0.315	0.339	0.318
X	0.296	0.287	0.307	0.311																										
Y	0.276	0.295	0.315	0.294																										
X	0.311	0.307	0.33	0.33																										
Y	0.294	0.315	0.339	0.318																										
For White colour only																														

Electrical Information	
Rated Constant Voltage	24V±2%
Rated Constant Current	350 mA
Power Consumption	8.4 W
Casing temperature, After 60 minutes operation	55.6 °C

Strobe Mode Specification	
*Normal Strobe Voltage	24 V
*Normal Strobe Current	350 mA
Overdrive Voltage Range	Min: 36V Max: 48V
Overdrive Current Range	Min: 2.5 A Max: 2.5 A
Recommended Overdrive Voltage	36V
**Max. Trigger Pulse Duration	10 msec
**Max. Duty Cycle	10%

*Normal strobe means the lighting is operated using the rated power. Overdrive means the power supplied to the lighting exceeded the rated power.

**Overdrive condition must not exceed the max. trigger pulse duration and max. duty cycle.



OPTO ENGINEERING

ILLUMINATOR DATA

LT2QOG040-00-X-W-24V

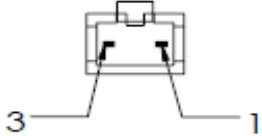
Connection Information			
Connector Type (Default)	JST SMR-03V		
Cable Length	50 cm		
Pin Configuration 	Pin	Signal	Cable Colour
	1	LED +	Red
	2	N.C	-
	3	LED -	White
			

Additional Information	
Additional Cooling Method	Attached to machine part for better heat dissipation
Intensity Controller Selection	SD, ST, ANG, LC, SDA, SDP series
CE Conformity	YES
RoHS Compliance	YES

Application	
Illumination Type	Coaxial Illumination
Application Use	Surface Inspection and Alignment, Wafer and Metal Surface Inspection, Film, LCD, and Glass, Pattern on PCB Inspection.



OPTO ENGINEERING

ILLUMINATOR DATA

LT2QOG040-00-X-W-24V

Lighting Pattern				
Working Distance	For further details please contact us.			
Display and Image				
Data Results	Horizontal	Meas.(mm)	Vertical	Meas.(mm)
	90%		90%	
	80%		80%	
	70%		70%	
	60%		60%	
	50%		50%	
	40%		40%	
	30%		30%	
	20%		20%	
	10%		10%	